

Nachdruck und jede
Vervielfältigung strengstens
verboten.

Polytechnisches Institut J. Schröder, A. G., Darmstadt.

Polytechnisches ~~Arbeits-~~Institut

J. SCHRÖDER
ACTIEN-GESELLSCHAFT
DARMSTADT.

Fabrik f. Unterrichts-Modelle, Zeichen- u. Mal-Geräthe.

ILLUSTRATIONEN

von

Unterrichts-Modellen

und

Apparaten.

Extra-Ausgabe zur Preisliste für Unterrichts-Modelle.

*Fernere in losen Blättern erscheinende
Illustrationen von inzwischen hergestellten Modellen werden auf
Verlangen nachgeliefert.*

— 2. Band. —

August 1902.

Buchdruckerei von H. Uhde, Darmstadt.

Deutsches Museum

München
J. SCHRODER IN DARMSTADT.

SCHUBKURBELKETTE

u. deren kinematische Umkehrungen

für Dampfmaschinen, Pumpen, Ventilatoren u. diverse Arbeitsmaschinen.
nach Reuleaux.

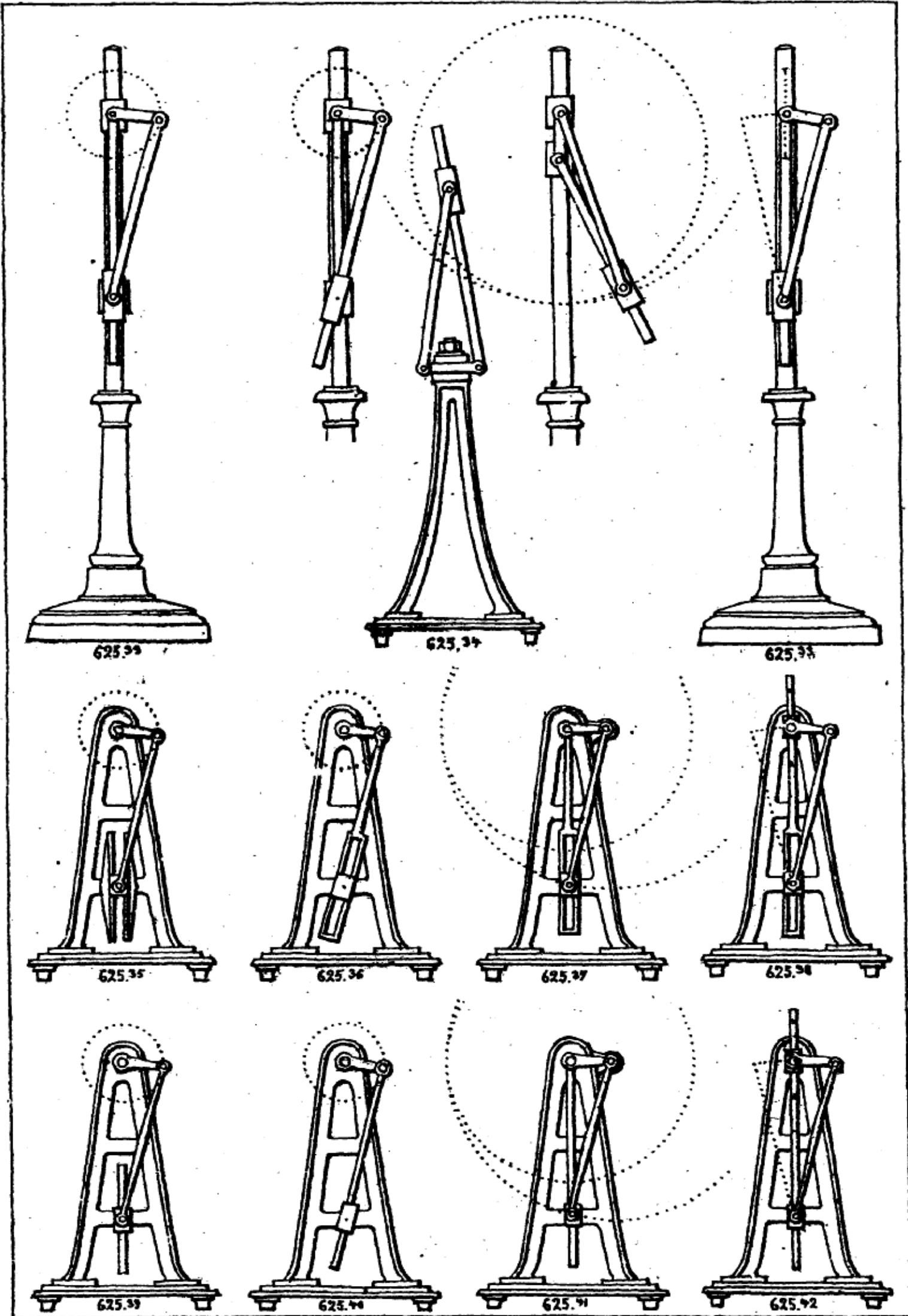

J. SCHRÖDER IN DARMSTADT.

SCHUBKURBELKETTE,
angewendet, u. rechtwinklige Kreuzschleifenkette;
für Dampfmaschinen, Pumpen u. diverse Arbeitsmaschinen,
nach Reuleaux.

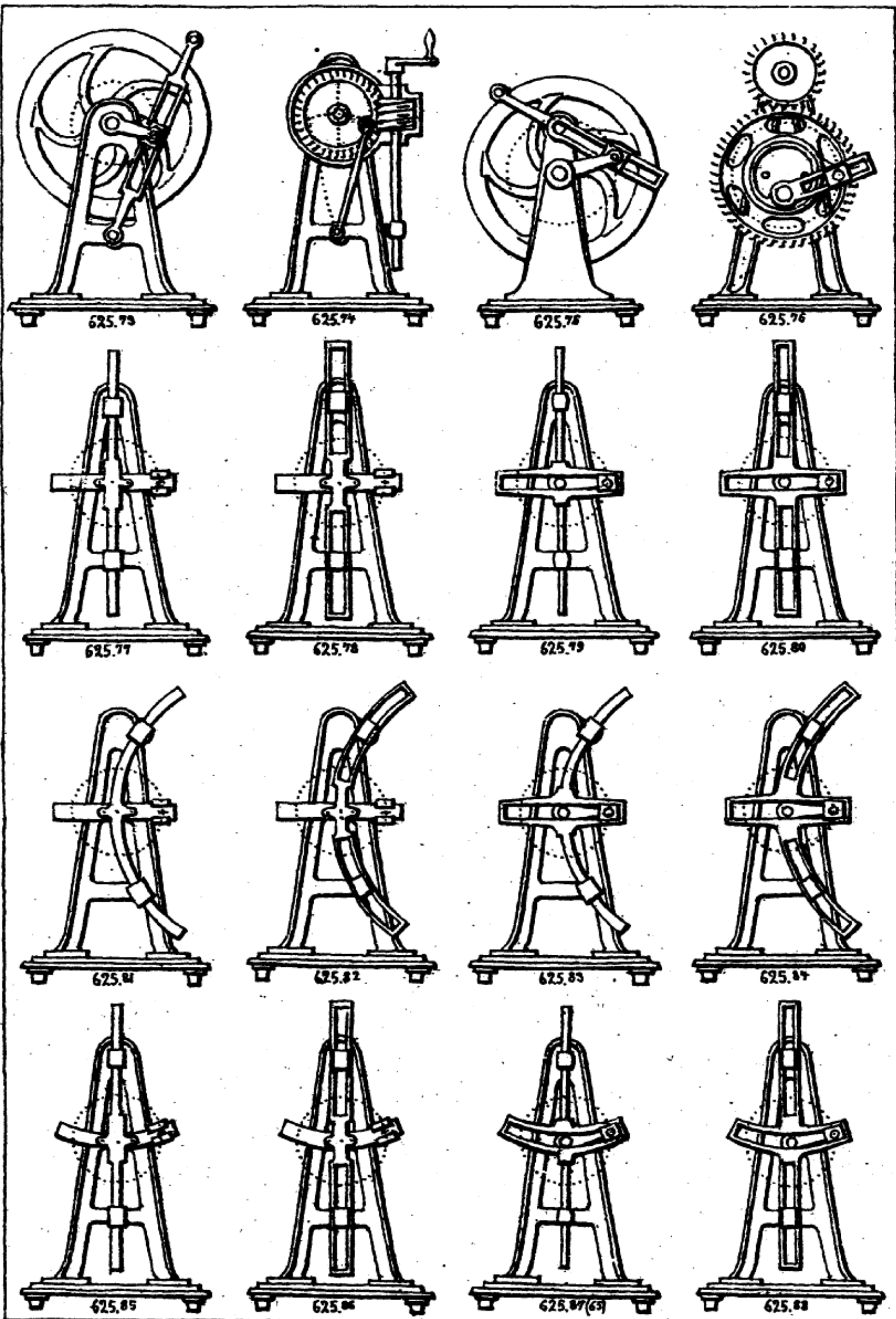

Deutsches Museum

München

J. SCHRÖDER IN DARMSTADT.

SCHUBKURBELKETTE

u. deren kinematische Umkehrungen, mit Zapfen-Erweiterung;
für Dampfmaschinen, Pumpen, Ventilatoren u. diverse Arbeitsmaschinen;
nach Reuleaux.

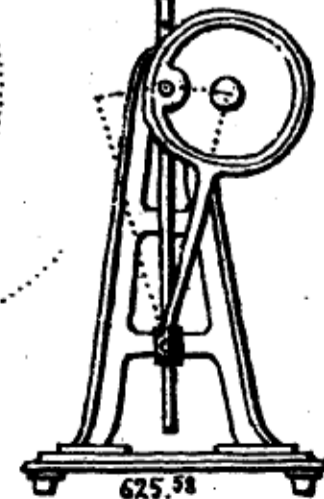
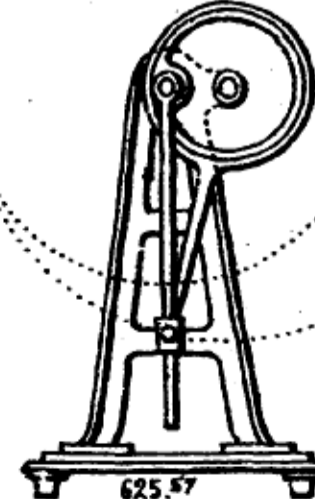
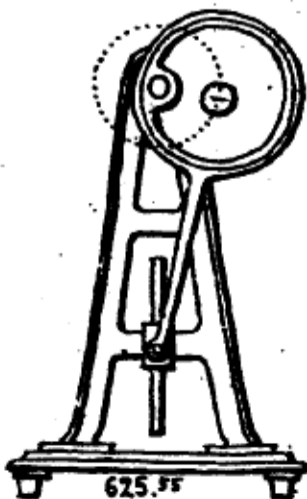
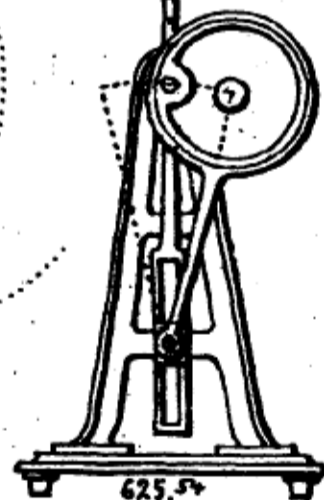
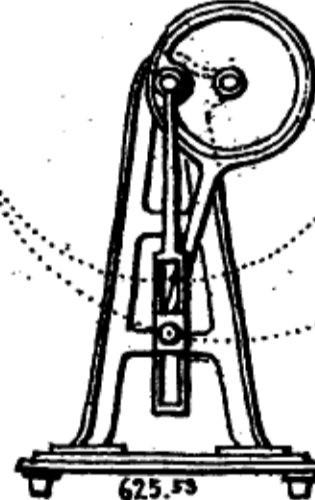
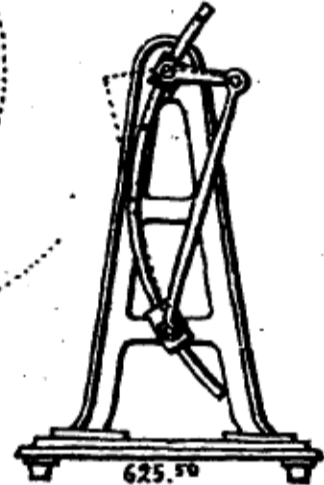
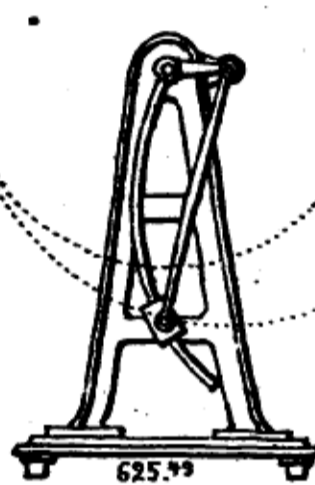
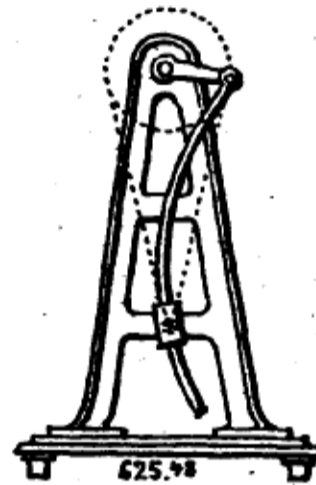
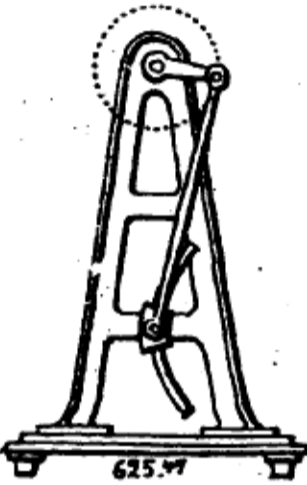
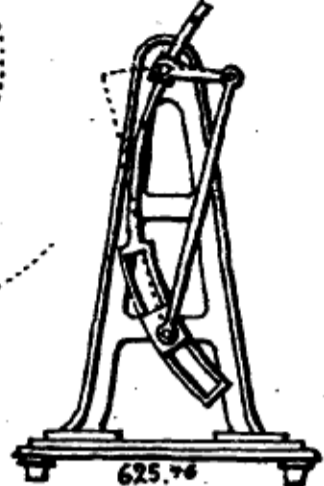
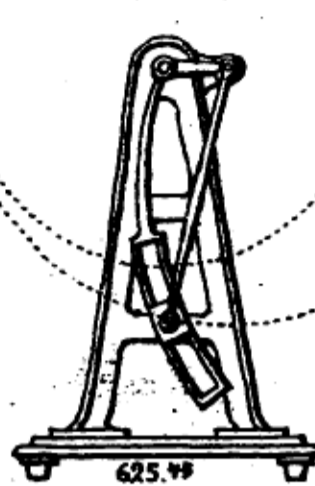
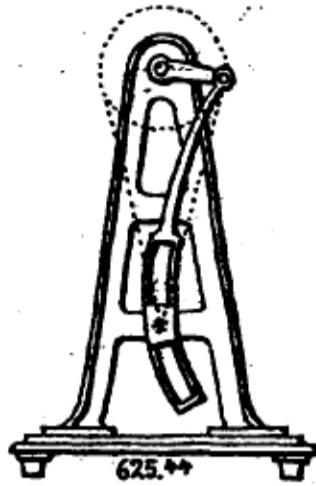
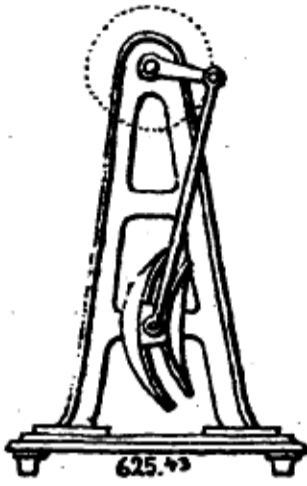

München

J. SCHRÖDER IN DARMSTADT.

Deutsches Museum
München

SCHUBKURBELKETTE,
gleichschenkelige, u. kinematische Zapfen-Erweiterung,
für Dampfmaschinen, Pumpen, Ventilatoren u. diverse Arbeitsmaschinen,
nach Reuleaux.

